

**Redaelli**



**wire  
Ropes**

for **Offshore**

# The sense of safety

*Do you know that awkward feeling in your stomach when stepping into an overcrowded cablecar? Or those moments driving across a long suspension bridge in a high wind?*

*Whether gliding through a scenic winter landscape or being whisked up to the 31<sup>st</sup> floor of a skyscraper.*

*It is in these moments of life that we depend on steel wires and wire ropes. Hopefully the manufacturer of those wires and wire ropes has laid great emphasis on safety aspects.*

*Our Company, Redaelli, is one of the global leaders in the production of steel wire ropes. We draw on almost 200 years of experience in our field and, as a result, we have established an excellent international reputation for our stringent safety policy.*

*"The sense of safety" is our mission and we take these words very seriously at every stage of our production and service chain.*

*Safety does not only mean making products safe.*

*To us, guaranteeing safety also means to calculate the durability of a product in full operation. We want people that enter a cablecar, cross a bridge or work under a crane, to feel safe,*





*because they know that safety is our first priority.*

Maurizio Prete



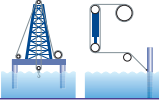
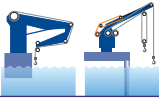
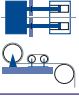
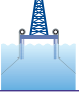

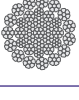
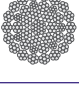
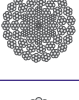
# Contents

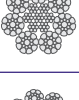
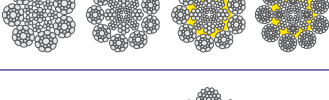
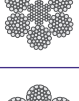
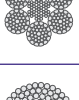
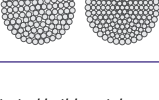
<b>Product applications:</b>	<b>Drilling and Risers</b>		<b>4</b>	<b>Socket tables: Open Spelter Sockets</b>	<b>22</b>		
	<b>Knuckle Boom Cranes and Pedestal Cranes</b>		<b>5</b>		<b>Closed Spelter Sockets - CR Sockets</b>	<b>23</b>	
	<b>Offshore Linear and Traction Winches</b>		<b>6</b>		<b>Sockets for Permanent Mooring Lines</b>	<b>25</b>	
	<b>Anchoring</b>		<b>7</b>		<b>Technical information:</b>	<b>Handling - Storage</b>	<b>26</b>
	<b>Mooring Lines PML</b>		<b>9</b>			<b>Installation on drum - Training</b>	<b>27</b>
<b>Wire rope tables:</b>	<b>Flexpack 15</b>		<b>11</b>	<b>Elastic modulus and elongation at break</b>	<b>29</b>		
	<b>Flexpack 18</b>		<b>12</b>	<b>Radial stiffness</b>	<b>30</b>		
	<b>Flexpack 21</b>		<b>13</b>	<b>Loss of strength due to ageing</b>	<b>31</b>		
	<b>6x19 API9A Metric</b>		<b>14</b>	<b>Rotation stability</b>	<b>32</b>		
	<b>6x19 API9A Imperial</b>		<b>15</b>	<b>Rotation trend - Bending stiffness</b>	<b>33</b>		
	<b>7xK19 Drilling</b>		<b>16</b>	<b>Swivels - End terminations</b>	<b>35</b>		
	<b>Pack9 Pack9P</b>		<b>17</b>	<b>Summary of technical coefficients</b>	<b>37</b>		
	<b>Red1</b>		<b>18</b>	<b>Use and warnings</b>	<b>38</b>		
	<b>Pack1</b>		<b>19</b>	<b>Serving - Socketing</b>	<b>39</b>		
	<b>Spiral Ropes</b>		<b>21</b>	<b>Inspection</b>	<b>40</b>		
					<b>Lubrication</b>	<b>41</b>	

We reserve the right to make modifications to the elements illustrated in this catalogue, without notice, for the purposes of complying with operating requirements and improving efficiency.

# Applications

## Drilling

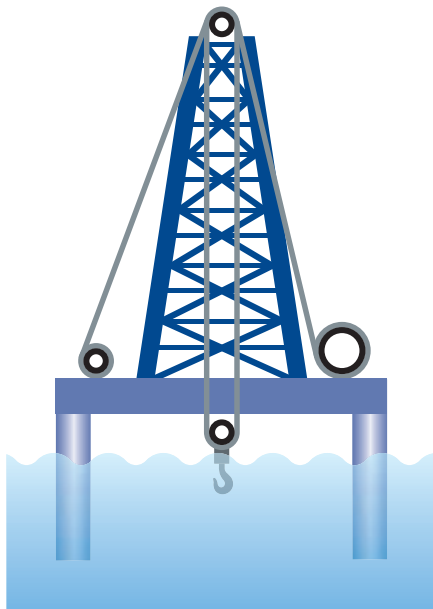

### 6x19 API

Conventional, according to international standard.

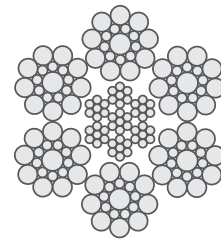

### 7xK19 Drilling

Higher breaking force with low wire grade, better contact surface, better stability, longer life, better wear and fatigue resistance.

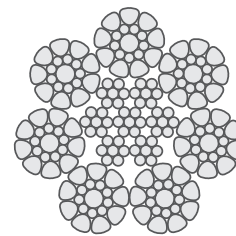

## Risers

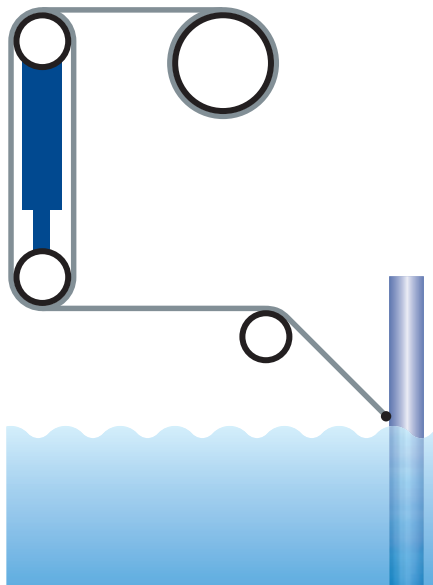

### Pack1

Higher breaking force, better stability, longer life, better wear and fatigue resistance.

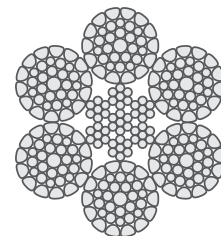

# Applications

## Knuckle Boom Cranes

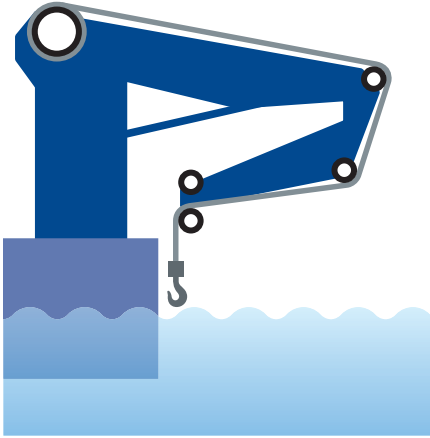

### Flexpack

Unarrivable low rotation characteristics, very high fill factor, high breaking force, low wire grade, resistance to fleet angles.

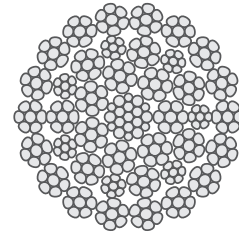

## Pedestal Cranes

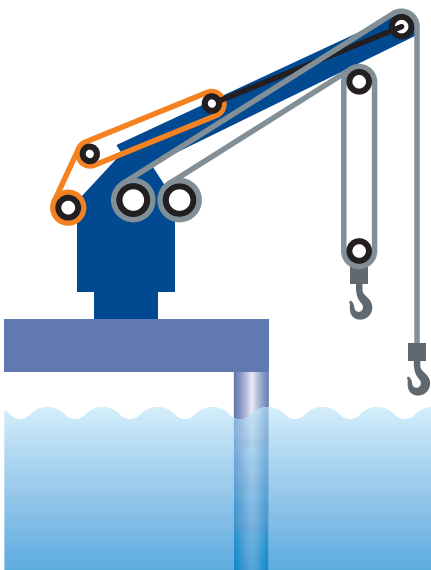

### Flexpack ◆

Unarrivable low rotation characteristics, very high fill factor, high breaking force, low wire grade, resistance to fleet angles.

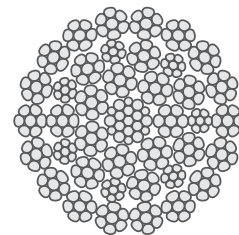

### Pack1 ◆

Resistance to crushing and side pressure, high breaking force, axial stiffness.

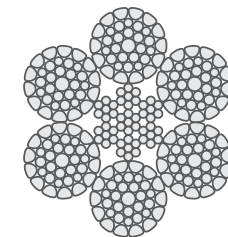

### Pack9 ◆

Better fatigue life, higher breaking force.

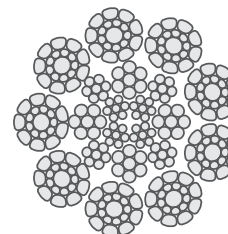

### Pack9P ◆

With plastic filling for better stability and resistance to fleet angles, better fatigue life, higher breaking force.

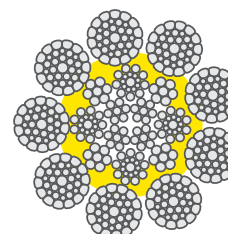

# Applications

## Offshore Winches

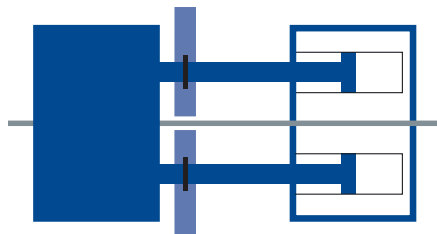

### Flexpack

Higher friction coefficient, low rotation characteristics, very high fill factor, better stiffness characteristics, high breaking force, resistance to fleet angles, better wear resistance.

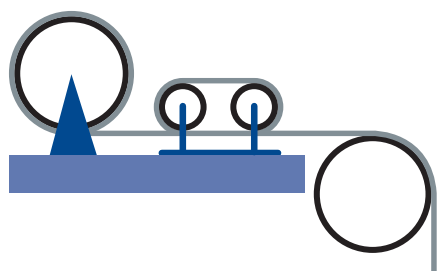
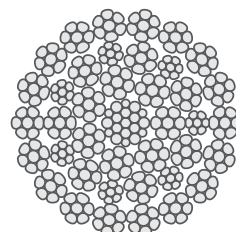

### Pack1

Resistance to crushing and side pressure, high breaking force, axial stiffness.

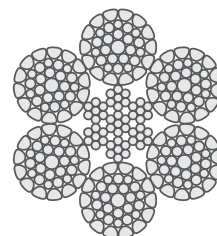

### Pack9

Better fatigue life, higher breaking force.

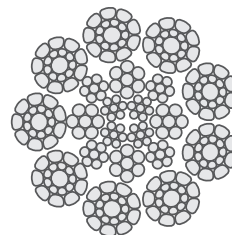

### Pack9P

With plastic filling for better stability and resistance to fleet angles, better fatigue life, higher breaking force.

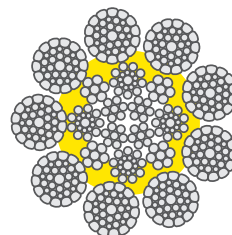

# Applications

## Anchoring

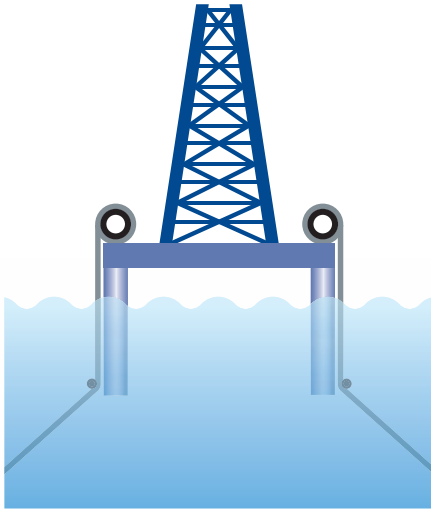

### Red1

Heavy galvanization and zinc anodes for longer life in service, up to 10 years.

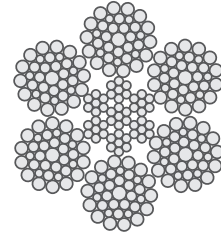

### Pack1

Higher breaking force, heavy galvanization and zinc anodes for longer life in service, up to 10 years.

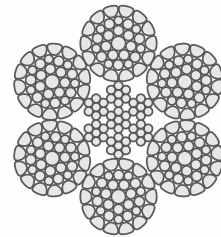



# Applications

## Mooring Lines PML

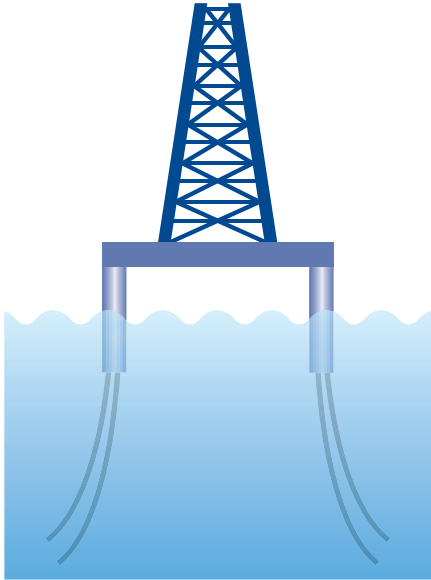

### Spiral Ropes

Heavy galvanization or Zn95Al5 for service life over 10 years.

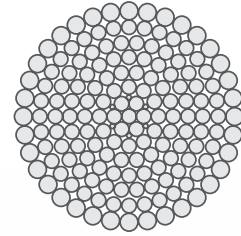



SAIPEN

7000

# Flexpack 15 Outer Strands

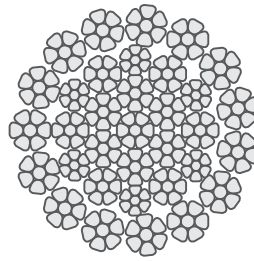

Nom. diameter		Mass				MBF		
Metric	Imperial	Air		Water		Grade 1960		
		Metric	Imperial	Metric	Imperial	Int.	Metric	Imperial
mm	inches	kg/m	lb/ft	kg/m	lb/ft	kN	Mtons	Shtons
	1	3,16	2,12	2,69	1,80	594	60,5	66,8
26		3,31	2,22	2,81	1,89	622	63,4	70,0
28		3,84	2,57	3,26	2,18	721	73,5	81,2
	1 1/8	4,00	2,68	3,40	2,28	751	76,6	84,5
30		4,41	2,95	3,75	2,51	828	84,4	93,2
	1 1/4	4,94	3,31	4,20	2,81	927	94,5	104
32		5,02	3,36	4,27	2,86	942	96,0	106
34		5,66	3,80	4,81	3,23	1060	108	120
35	1 3/8	5,98	4,00	5,08	3,40	1120	114	126
36		6,35	4,25	5,40	3,61	1190	122	134
38	1 1/2	7,08	4,74	6,02	4,03	1330	135	149
40		7,84	5,25	6,66	4,46	1470	150	166

Figures shown in this page represent the characteristics of the standard products. Redaelli is in position to design wire ropes to suit your individual needs. Please contact us directly and we will be pleased to design a specific wire rope to match your requirements.



# Flexpack 18 Outer Strands

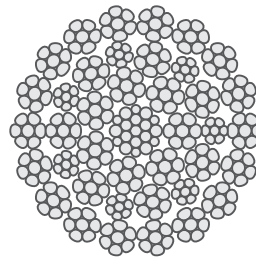

Nom. diameter		Mass				MBF					
Metric	Imperial	Air		Water		Grade 1770			Grade 1960		
		Metric	Imperial	Metric	Imperial	Int.	Metric	Imperial	Int.	Metric	Imperial
mm	inches	kg/m	lb/ft	kg/m	lb/ft	kN	Mtons	Shtons	kN	Mtons	Shtons
42		8,64	5,79	7,35	4,92				1620	165	183
44		9,49	6,36	8,06	5,41				1780	182	200
44,5	1 3/4	9,68	6,49	8,23	5,51				1820	185	205
46		10,4	6,95	8,83	5,91				1950	198	219
48	1 7/8	11,3	7,57	9,58	6,43				2120	216	238
50		12,3	8,21	10,4	6,98				2300	234	259
	2	12,6	8,48	10,7	7,21				2370	242	267
52		13,2	8,88	11,2	7,55				2490	254	280
54	2 1/8	14,3	9,57	12,2	8,14				2680	273	302
56		15,4	10,3	13,1	8,75				2890	294	325
58	2 1/4	16,5	11,1	14,0	9,41				3090	315	348
60	2 3/8	17,8	12,0	15,2	10,2				3350	341	377
62		18,8	12,6	16,0	10,7				3540	360	398
64	2 1/2	20,1	13,4	17,1	11,4				3770	384	424
66		21,4	14,3	18,2	12,2				4010	409	451
	2 5/8	21,8	14,6	18,5	12,4				4090	417	460
68		22,6	15,2	19,2	12,9				4250	434	479
70	2 3/4	24,0	16,1	20,4	13,7				4510	460	507
72		25,4	17,1	21,6	14,5				4770	486	537
73	2 7/8	26,2	17,5	22,2	14,9				4910	500	552
74		26,9	17,9	22,8	15,2				5040	514	567
76		28,3	18,9	24,1	16,1				5310	542	598
	3	28,4	19,1	24,2	16,2				5340	545	601
77		29,0	19,5	24,7	16,6	5400	550	607			
80	3 1/8	31,4	21,0	26,7	17,8	5820	594	655			
82	3 1/4	33,4	22,3	28,4	19,0	6060	618	682			
84		34,6	23,1	29,4	19,7	6280	640	707			
86	3 3/8	36,3	24,3	30,8	20,7	6580	671	741			
88		37,9	25,4	32,2	21,6	6810	695	767			
90	3 1/2	39,7	26,6	33,7	22,6	7130	727	802			
92	3 5/8	41,6	27,8	35,3	23,7	7460	760	839			
94		43,3	29,0	36,8	24,7	7690	784	865			
95	3 3/4	44,5	29,8	37,8	25,3	7800	795	878			
96		45,2	30,3	38,4	25,7	7830	799	881			
98	3 7/8	47,4	31,9	40,3	27,1	8230	839	926			
100		49,0	32,8	41,7	27,9	8500	866	956			
102	4	51,0	34,2	43,3	29,1	8840	901	995			
104		53,0	35,5	45,1	30,2	9190	937	1030			
105	4 1/8	54,0	36,2	45,9	30,7	9370	955	1050			
106		55,1	36,8	46,8	31,3	9550	974	1070			
108	4 1/4	57,1	38,3	48,6	32,6	9910	1010	1120			
109		58,2	39,0	49,5	33,2	10100	1030	1140			
110		59,3	39,7	50,4	33,7	10200	1040	1140			
112	4 3/8	61,4	41,2	52,2	35,0	10500	1070	1190			
114	4 1/2	64,0	42,9	54,4	36,5	11000	1120	1230			
115		64,8	43,4	55,1	36,9	11100	1130	1250			
117	4 5/8	67,6	45,3	57,5	38,5	11600	1180	1300			
119		69,4	46,5	59,0	39,5	11900	1210	1340			
120	4 3/4	71,3	47,8	60,6	40,7	12200	1250	1380			
122		72,9	48,9	62,0	41,6	12400	1260	1390			
124	4 7/8	75,4	50,5	64,1	42,9	12800	1300	1440			
125		76,5	51,3	65,1	43,6	13000	1320	1460			
126		77,8	52,1	66,1	44,3	13200	1340	1480			
127	5	79,0	52,9	67,1	45,0	13400	1360	1510			
128		80,3	53,8	68,2	45,7	13600	1390	1530			

Figures shown in this page represent the characteristics of the standard products. Redaelli is in position to design wire ropes to suit your individual needs. Please contact us directly and we will be pleased to design a specific wire rope to match your requirements.



# Flexpack 21 Outer Strands

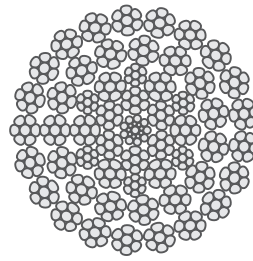

Nom. diameter		Mass				MBF					
Metric	Imperial	Air		Water		Grade 1770			Grade 1960		
		Metric	Imperial	Metric	Imperial	Int.	Metric	Imperial	Int.	Metric	Imperial
mm	inches	kg/m	lb/ft	kg/m	lb/ft	kN	Mtons	Shtons	kN	Mtons	Shtons
109		55,3	37,0	47,0	31,5				9860	1010	1110
110		56,4	37,7	47,9	32,1				10000	1020	1130
112	4 3/8	58,4	39,1	49,6	33,2				10400	1060	1170
114	4 1/2	60,9	40,8	51,7	34,7				10800	1110	1220
115		61,5	41,3	52,3	35,1				10800	1110	1220
117	4 5/8	64,3	43,0	54,6	36,6				11300	1150	1270
119		66,0	44,2	56,1	37,6				11600	1180	1310
120	4 3/4	67,7	45,4	57,6	38,6				11900	1220	1340
122		69,3	46,5	58,9	39,5				12200	1240	1370
124	4 7/8	71,5	47,9	60,8	40,7				12600	1290	1420
125		72,7	48,7	61,8	41,4				12800	1310	1440
126		73,9	49,5	62,8	42,1				13000	1330	1460
127	5	75,1	50,3	63,8	42,7				13200	1350	1490
128		76,2	51,1	64,8	43,4				13400	1370	1510
130	5 1/8	78,9	52,8	67,1	44,9				13900	1420	1560
132		81,1	54,4	69,0	46,2				14300	1460	1610
134	5 1/4	83,6	56,0	71,1	47,6				14700	1500	1660
135		84,9	56,8	72,1	48,3				14900	1520	1680
136	5 3/8	86,7	58,1	73,7	49,4				15300	1560	1720
138		88,7	59,4	75,4	50,5				15600	1590	1760
139		90,0	60,3	76,5	51,2				15800	1620	1780
140	5 1/2	91,2	61,2	77,6	52,0				16100	1640	1810
142	5 5/8	95,1	63,7	80,8	54,1				16700	1710	1880
144		96,5	64,7	82,1	55,0				17000	1730	1910
146	5 3/4	99	66,5	84,1	56,6				17500	1780	1970
148		102	68,3	86,6	58,1				18000	1830	2020
150	5 7/8	105	70,2	89,1	59,6				18500	1880	2080
152	6	108	72,4	91,6	61,6				19000	1940	2140
154		111	74,0	94,1	62,9				19400	1980	2190
156	6 1/8	114	75,9	96,6	64,5				20000	2030	2250
158	6 1/4	118	78,6	100	66,8				20700	2110	2330
160		120	79,9	102	67,9				21000	2140	2360
162	6 3/8	123	81,7	104	69,5	21200	2160	2390			
164		125	83,9	107	71,3	21500	2190	2420			
165	6 1/2	126	85,0	107	72,2	21800	2220	2450			
166		128	85,9	109	73,1	21800	2220	2450			
168	6 5/8	132	88,3	112	75,1	22400	2280	2520			
170		134	90,2	114	76,6	22800	2330	2570			
172	6 3/4	138	92,3	117	78,5	23100	2350	2600			
174		141	94,5	120	80,3	23300	2380	2620			
175	6 7/8	142	95,6	121	81,2	23300	2370	2620			

Figures shown in this page represent the characteristics of the standard products. Pedaelli is in position to design wire ropes to suit your individual needs. Please contact us directly and we will be pleased to design a specific wire rope to match your requirements.



# 6x19 API Metric



Nom. diameter		Mass		MBF								
Metric	Imperial	Air		Grade 1770			Grade 1960			Grade 2160		
		Metric	Imperial	Int.	Metric	Imperial	Int.	Metric	Imperial	Int.	Metric	Imperial
mm	inches	kg/m	lb/ft	kN	Mtons	Shtons	kN	Mtons	Shtons	kN	Mtons	Shtons
26		2,70	1,82	426	43,4	47,9	472	48,1	53,1	520	53,0	58,5
28		3,14	2,11	494	50,4	55,6	547	55,8	61,5	603	61,5	67,8
32		4,10	2,76	645	65,7	72,6	715	72,9	80,4	787	80,2	88,5
35	1 3/8	4,90	3,30	772	78,7	86,9	855	87,2	96,2	942	96,0	106
36		5,18	3,48	817	83,3	91,9	904	92,2	102	997	102	112
38	1 1/2	5,78	3,89	910	92,8	102	1010	103	114	1110	113	125
40		6,40	4,30	1010	103	114	1120	114	126	1230	125	138
44		7,74	5,21	1220	124	137	1350	138	152	1490	152	168
44,5	1 3/4	8,10	5,45	1280	130	144	1410	144	159	1570	160	177
48	1 7/8	9,22	6,20	1450	148	163	1610	164	181	1770	180	199
	2	10,4	6,99	1640	167	185	1810	185	204	2000	204	225
52		10,8	7,26	1700	173	191	1890	193	213	2080	212	234
56		12,5	8,41	1980	202	223	2190	223	246	2410	246	271
60	2 3/8	14,4	9,68	2270	231	255	2510	256	282	2770	282	312

Figures shown in this page represent the characteristics of the standard products. Redaelli is in position to design wire ropes to suit your individual needs. Please contact us directly and we will be pleased to design a specific wire rope to match your requirements.



# 6x19 API Imperial



Nom. diameter		Mass		MBF								
Metric	Imperial	Air		IPS			EIP			EEIP		
		Metric	Imperial	Int.	Metric	Imperial	Int.	Metric	Imperial	Int.	Metric	Imperial
mm	inches	kg/m	lb/ft	kN	Mtons	Shtons	kN	Mtons	Shtons	kN	Mtons	Shtons
	1	2,76	1,85	399	40,7	44,9	460	46,9	51,8	509	51,9	57,3
	1 1/8	3,49	2,34	503	51,3	56,6	578	58,9	65,0	636	64,8	71,6
	1 1/4	4,32	2,89	617	62,9	69,4	711	72,5	80,0	782	79,7	88,0
35	1 3/8	5,21	3,49	743	75,7	83,6	854	87,1	96,1	943	96,1	106
38	1 1/2	6,21	4,16	880	89,7	99,0	1010	103	114	1110	113	125
41	1 5/8	7,29	4,88	1020	104	115	1170	119	132	1300	133	146
44,5	1 3/4	8,45	5,66	1180	120	133	1360	139	153	1500	153	169
48	1 7/8	9,69	6,49	1350	138	152	1550	158	174	1710	174	192
	2	11,0	7,39	1530	156	172	1760	179	198	1930	197	217
54	2 1/8	12,5	8,34	1710	174	192	1970	201	222	2160	220	243
58	2 1/4	14,0	9,35	1910	195	215	2200	224	248	2420	247	272

Figures shown in this page represent the characteristics of the standard products. Redaelli is in position to design wire ropes to suit your individual needs. Please contact us directly and we will be pleased to design a specific wire rope to match your requirements.



# 7xK19 Drilling

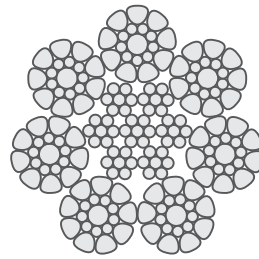

Nom. diameter		Mass		MBF								
Metric	Imperial	Air		Grade 1770			Grade 1960			Grade 2160		
		Metric	Imperial	Int.	Metric	Imperial	Int.	Metric	Imperial	Int.	Metric	Imperial
mm	inches	kg/m	lb/ft	kN	Mtons	Shtons	kN	Mtons	Shtons	kN	Mtons	Shtons
	1	2,78	1,87	445	45,4	50,1	510	52,0	57,3	561	57,2	63,1
26		2,91	1,96	466	47,5	52,5	534	54,4	60,1	588	60,0	66,2
28		3,38	2,27	541	55,1	60,9	619	63,1	69,7	682	69,5	76,7
	1 1/8	3,52	2,36	563	57,4	63,4	645	65,8	72,6	710	72,4	79,9
30		3,88	2,60	621	63,3	69,9	711	72,5	80,0	783	79,8	88,1
	1 1/4	4,35	2,92	696	70,9	78,3	796	81,2	89,6	877	89,4	98,7
32		4,42	2,96	707	72,0	79,5	809	82,5	91,0	891	90,8	100
34		4,98	3,34	798	81,3	89,7	913	93,1	103	1000	102	113
35	1 3/8	5,26	3,53	842	85,8	94,7	964	98,2	108	1040	106	117
36		5,59	3,75	894	91,2	101	1020	104	115	1110	113	125
38	1 1/2	6,23	4,18	996	102	112	1140	116	128	1240	126	140
40		6,90	4,63	1100	112	124	1240	126	140	1370	140	154
41	1 5/8	7,35	4,93	1170	119	132	1320	135	149	1460	149	164
42		7,61	5,10	1210	123	136	1370	140	154	1510	154	170
44		8,35	5,60	1330	136	150	1510	154	170	1660	169	187
44,5	1 3/4	8,52	5,71	1340	137	151	1540	157	173	1670	170	188
46		9,12	6,12	1430	146	161	1650	168	186	1790	182	201
48	1 7/8	9,93	6,66	1560	159	176	1790	182	201	1950	199	219
50		10,8	7,23	1700	173	191	1950	199	219	2120	216	239
	2	11,1	7,46	1750	178	197	1980	202	223	2190	223	246
52		11,7	7,82	1830	187	206	2080	212	234	2270	231	255
54	2 1/8	12,6	8,43	1950	199	219	2240	228	252	2440	249	275
56		13,5	9,07	2100	214	236	2410	246	271	2630	268	296
58	2 1/4	14,5	9,73	2250	229	253	2590	264	291	2820	287	317
60	2 3/8	15,7	10,5	2430	248	273	2800	285	315	3050	311	343

Figures shown in this page represent the characteristics of the standard products. Redaelli is in position to design wire ropes to suit your individual needs. Please contact us directly and we will be pleased to design a specific wire rope to match your requirements.



# Pack9 - Pack9P

## Class 8xK36-IWRC

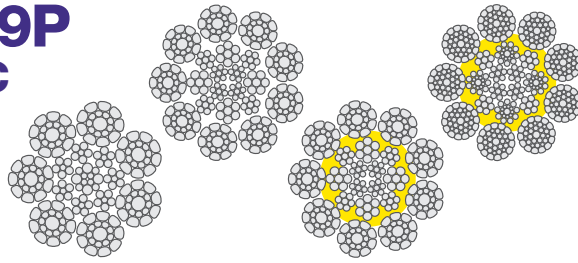

Nom. diameter		Mass				MBF								
Metric	Imperial	Air		Water		Grade 1770			Grade 1960			Grade 2160		
		Metric	Imperial	Metric	Imperial	Int.	Metric	Imperial	Int.	Metric	Imperial	Int.	Metric	Imperial
mm	inches	kg/m	lb/ft	kg/m	lb/ft	kN	Mtons	Shtons	kN	Mtons	Shtons	kN	Mtons	Shtons
40		7,44	4,98	6,32	4,23							1540	157	173
41	1 5/8	7,92	5,31	6,73	4,51							1640	167	184
42		8,20	5,50	6,97	4,68							1690	173	191
44		9,00	6,03	7,65	5,13							1860	189	209
44,5	1 3/4	9,19	6,16	7,81	5,24							1900	193	213
46		9,84	6,59	8,36	5,60							2010	205	226
48	1 7/8	10,7	7,18	9,10	6,10							2190	223	246
50		11,6	7,79	9,86	6,62							2380	242	267
	2	12,0	8,04	10,2	6,83							2450	250	276
52		12,6	8,42	10,7	7,16							2540	259	286
54	2 1/8	13,6	9,08	11,6	7,72							2740	279	308
56		14,6	9,77	12,4	8,30							2950	300	332
58	2 1/4	15,6	10,5	13,3	8,93							3160	322	356
60	2 3/8	16,9	11,3	14,4	9,61							3380	345	381
62		17,9	12,0	15,2	10,2							3570	364	402
64	2 1/2	19,0	12,8	16,2	10,9							3810	388	429
66		20,3	13,6	17,3	11,6							4050	413	456
	2 5/8	20,7	13,9	17,6	11,8							4130	421	465
68		21,5	14,4	18,3	12,2							4300	438	484
70	2 3/4	22,8	15,3	19,4	13,0							4560	465	513
72		24,1	16,2	20,5	13,8							4820	491	542
73	2 7/8	24,8	16,6	21,1	14,1							4960	506	558
74		25,5	17,1	21,7	14,5							5040	514	567
76		26,9	18,0	22,9	15,3							5310	542	598
	3	27,0	18,1	23,0	15,4							5340	545	601
77		27,6	18,5	23,5	15,7							5450	556	614
80	3 1/8	29,8	19,9	25,3	16,9							5890	600	662
82	3 1/4	31,7	21,2	26,9	18,0							6270	639	705
84		32,8	22,0	27,9	18,7							6490	662	730
86	3 3/8	34,4	23,0	29,2	19,6							6800	694	766
88		36,0	24,1	30,6	20,5							7120	726	802
90	3 1/2	37,7	25,2	32,0	21,4							7450	760	838
92	3 5/8	39,4	26,4	33,5	22,4				7710	786	868			
94		41,1	27,5	34,9	23,4				7950	811	895			
95	3 3/4	42,2	28,3	35,9	24,1				8170	832	919			
96		42,9	28,7	36,5	24,4				8290	846	933			
98	3 7/8	45,0	30,2	38,3	25,7				8520	869	959			
100		46,5	31,2	39,5	26,5				8800	897	990			
102	4	48,4	32,4	41,1	27,5				9050	923	1020			
104		50,3	33,7	42,8	28,6				9300	948	1050			
105	4 1/8	51,3	34,3	43,6	29,2				9370	955	1050			
106		52,2	35,0	44,4	29,8				9440	962	1060			
108	4 1/4	54,2	36,3	46,1	30,9				9680	987	1090			
109		55,2	37,0	46,9	31,5	9740	993	1100						
110		56,3	37,7	47,9	32,0	9800	999	1100						
112	4 3/8	58,3	39,1	49,6	33,2	10200	1040	1140						
114	4 1/2	60,7	40,7	51,6	34,6	10600	1080	1190						
115		61,5	41,2	52,3	35,0	10600	1080	1190						
117	4 5/8	64,2	43,0	54,6	36,6	11000	1130	1240						
119		65,8	44,1	55,9	37,5	11300	1150	1270						

Figures shown in this page represent the characteristics of the standard products. Redaelli is in position to design wire ropes to suit your individual needs. Please contact us directly and we will be pleased to design a specific wire rope to match your requirements.



# Red1

## Class 6x36-IWRC

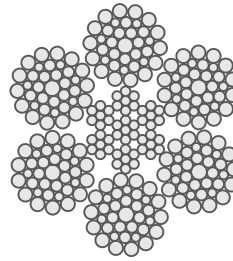

Nom. diameter		Mass				MBF					
Metric	Imperial	Air		Water		Grade 1770			Grade 1960		
		Metric	Imperial	Metric	Imperial	Int.	Metric	Imperial	Int.	Metric	Imperial
mm	inches	kg/m	lb/ft	kg/m	lb/ft	kN	Mtons	Shtons	kN	Mtons	Shtons
40		6,80	4,56	5,78	3,88				1340	137	151
41	1 5/8	7,24	4,85	6,15	4,12				1430	146	161
42		7,50	5,02	6,38	4,27				1480	151	167
44		8,23	5,51	7,00	4,68				1630	166	183
44,5	1 3/4	8,40	5,63	7,14	4,79				1660	169	187
46		8,99	6,03	7,64	5,13				1780	181	200
48	1 7/8	9,79	6,56	8,32	5,58				1940	197	218
50		10,6	7,12	9,01	6,05				2100	214	236
	2	11,0	7,35	9,35	6,25				2170	221	244
52		11,5	7,70	9,78	6,55				2270	232	256
54	2 1/8	12,4	8,30	10,5	7,06				2450	250	276
56		13,3	8,93	11,3	7,59				2630	269	296
58	2 1/4	14,3	9,58	12,2	8,14				2830	288	318
60	2 3/8	15,5	10,4	13,2	8,84				3060	312	344
62		16,3	10,9	13,9	9,27				3230	329	363
64	2 1/2	17,4	11,7	14,8	9,95				3440	351	387
66		18,5	12,4	15,7	10,5				3620	369	407
	2 5/8	18,9	12,7	16,1	10,8				3690	376	415
68		19,7	13,2	16,7	11,2				3840	391	432
70	2 3/4	20,8	14,0	17,7	11,9				4070	415	458
72		22,0	14,8	18,7	12,6				4250	433	478
73	2 7/8	22,7	15,2	19,3	12,9				4370	446	492
74		23,3	15,6	19,8	13,3				4490	458	505
76		24,5	16,4	20,8	13,9				4740	483	533
	3	24,7	16,5	21,0	14,0				4760	485	536
77		25,2	16,9	21,4	14,4	4800	490	540			
80	3 1/8	27,2	18,2	23,1	15,5	5180	528	583			
82	3 1/4	29,0	19,4	24,7	16,5	5520	563	621			
84		30,0	20,1	25,5	17,1	5720	583	643			
86	3 3/8	31,4	21,1	26,7	17,9	5990	611	674			
88		32,9	22,1	28,0	18,8	6270	639	706			
90	3 1/2	34,4	23,1	29,2	19,6	6560	669	738			
92	3 5/8	36,0	24,1	30,6	20,5	6610	674	744			
94		37,6	25,2	32,0	21,4	6890	703	775			
95	3 3/4	38,6	25,8	32,8	21,9	7080	721	796			
96		39,2	26,2	33,3	22,3	7190	733	809			
98	3 7/8	41,2	27,6	35,0	23,5	7360	751	828			
100		42,5	28,5	36,1	24,2	7600	775	855			
102	4	44,2	29,6	37,6	25,2	7910	806	890			
104		46,0	30,8	39,1	26,2	8110	827	913			
105	4 1/8	46,9	31,4	39,9	26,7	8270	843	930			
106		47,8	32,0	40,6	27,2	8430	859	948			
108	4 1/4	49,6	33,2	42,2	28,2	8750	892	984			
109		50,5	33,8	42,9	28,7	8910	908	1000			
110		51,4	34,5	43,7	29,3	8950	913	1010			
112	4 3/8	53,3	35,7	45,3	30,3	9280	946	1040			
114	4 1/2	55,5	37,2	47,2	31,6	9540	972	1070			
115		56,2	37,7	47,8	32,0	9650	984	1090			
117	4 5/8	58,7	39,3	49,9	33,4	9940	1010	1120			
119		60,2	40,3	51,2	34,3	10100	1020	1130			
120	4 3/4	61,9	41,4	52,6	35,2	10300	1050	1160			
122		63,3	42,4	53,8	36,0	10300	1050	1160			
124	4 7/8	65,3	43,8	55,5	37,2	10600	1080	1190			
125		66,4	44,5	56,4	37,8	10800	1100	1210			
126		67,5	45,2	57,4	38,4	11000	1120	1230			
127	5	68,5	45,9	58,2	39,0	11100	1130	1250			
128		69,6	46,7	59,2	39,7	11300	1150	1270			
130	5 1/8	72,0	48,3	61,2	41,1	11500	1170	1300			
132		74,1	49,6	63,0	42,2	11800	1210	1330			
134	5 1/4	76,3	51,1	64,9	43,4	12200	1240	1370			
135		77,5	51,9	65,9	44,1	12400	1260	1390			
136	5 3/8	79,2	53,1	67,3	45,1	12500	1270	1410			
138		80,9	54,2	68,8	46,1	12800	1300	1440			
139		82,1	55,0	69,8	46,8	12900	1320	1460			
140	5 1/2	83,3	55,8	70,8	47,4	12900	1320	1460			

Figures shown in this page represent the characteristics of the standard products. Redaelli is in position to design wire ropes to suit your individual needs. Please contact us directly and we will be pleased to design a specific wire rope to match your requirements.

# Pack1

## Class 6xK36-IWRC

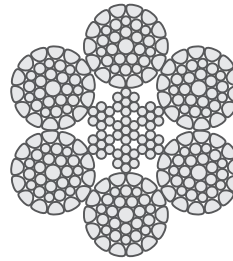

Nom. diameter		Mass				MBF					
Metric	Imperial	Air		Water		Grade 1770			Grade 1960		
		Metric	Imperial	Metric	Imperial	Int.	Metric	Imperial	Int.	Metric	Imperial
mm	inches	kg/m	lb/ft	kg/m	lb/ft	kN	Mtons	Shtons	kN	Mtons	Shtons
40		7,20	4,82	6,12	4,10				1420	145	160
41	1 5/8	7,67	5,14	6,52	4,37				1520	155	171
42		7,94	5,32	6,75	4,52				1570	160	177
44		8,71	5,84	7,40	4,96				1720	176	194
44,5	1 3/4	8,89	5,96	7,56	5,07				1760	179	198
46		9,52	6,38	8,09	5,42				1880	192	212
48	1 7/8	10,4	6,95	8,84	5,91				2050	209	231
50		11,3	7,54	9,61	6,41				2230	227	250
	2	11,6	7,78	9,86	6,61				2300	234	258
52		12,2	8,15	10,4	6,93				2380	243	268
54	2 1/8	13,1	8,79	11,1	7,47				2570	262	289
56		14,1	9,46	12,0	8,04				2760	281	310
58	2 1/4	15,1	10,1	12,8	8,59				2960	302	333
60	2 3/8	16,4	11,0	13,9	9,35				3200	326	360
62		17,3	11,6	14,7	9,86				3380	345	381
64	2 1/2	18,4	12,3	15,6	10,5				3600	367	406
66		19,6	13,1	16,7	11,1				3830	391	431
	2 5/8	20,0	13,4	17,0	11,4				3910	399	440
68		20,8	13,9	17,7	11,8				4070	415	458
70	2 3/4	22,0	14,8	18,7	12,6				4310	440	485
72		23,3	15,6	19,8	13,3				4560	465	513
73	2 7/8	24,0	16,1	20,4	13,7				4690	478	528
74		24,6	16,5	20,9	14,0				4820	491	542
76		26,0	17,4	22,1	14,8				5080	518	572
	3	26,1	17,5	22,2	14,9				5110	521	575
77		26,7	17,9	22,7	15,2				5220	532	587
80	3 1/8	28,8	19,3	24,5	16,4				5570	568	626
82	3 1/4	30,7	20,5	26,1	17,4				5930	604	667
84		31,8	21,3	27,0	18,1				6140	626	691
86	3 3/8	33,3	22,3	28,3	19,0				6430	656	724
88		34,8	23,3	29,6	19,8				6740	687	758
90	3 1/2	36,4	24,4	30,9	20,7				7050	718	793
92	3 5/8	38,2	25,6	32,5	21,8				7290	743	820
94		39,8	26,6	33,8	22,6				7600	775	855
95	3 3/4	40,8	27,4	34,7	23,3				7800	795	878
96		41,5	27,8	35,3	23,6				7830	799	881
98	3 7/8	43,6	29,2	37,1	24,8				8230	839	926
100		45,0	30,2	38,3	25,7				8400	856	945
102	4	46,8	31,4	39,8	26,7				8740	891	983
104		48,7	32,6	41,4	27,7				9090	926	1020
105	4 1/8	49,6	33,2	42,2	28,2				9150	933	1030
106		50,6	33,9	43,0	28,8				9330	951	1050
108	4 1/4	52,5	35,2	44,6	29,9	9330	951	1050			
109		53,5	35,8	45,5	30,4	9500	969	1070			
110		54,5	36,5	46,3	31,0	9560	974	1080			
112	4 3/8	56,4	37,8	47,9	32,1	9660	985	1090			

Figures shown in this page represent the characteristics of the standard products. Redaelli is in position to design wire ropes to suit your individual needs. Please contact us directly and we will be pleased to design a specific wire rope to match your requirements.





# Spiral Ropes

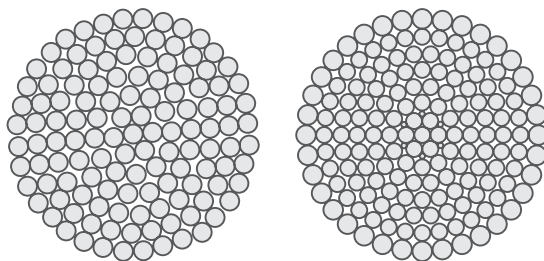

Nom. diameter		Mass				MBF					
Metric	Imperial	Air		Water		Grade 1770			Grade 1960		
		Metric	Imperial	Metric	Imperial	Int.	Metric	Imperial	Int.	Metric	Imperial
mm	inches	kg/m	lb/ft	kg/m	lb/ft	kN	Mtons	Shtons	kN	Mtons	Shtons
40		8,16	5,47	6,94	4,65				1600	163	180
41	1 5/8	8,69	5,82	7,39	4,95				1700	174	192
42		9,00	6,03	7,65	5,13				1760	180	198
44		9,87	6,62	8,39	5,63				1940	197	218
44,5	1 3/4	10,1	6,75	8,59	5,74				1980	201	222
46		10,8	7,23	9,18	6,15				2120	216	238
48	1 7/8	11,8	7,87	10,0	6,69				2300	235	259
50		12,8	8,54	10,9	7,26				2500	255	281
	2	13,2	8,82	11,2	7,50				2580	263	290
52		13,8	9,24	11,7	7,85				2700	276	304
54	2 1/8	14,9	9,96	12,7	8,47				2920	297	328
56		16,0	10,7	13,6	9,10				3140	320	353
58	2 1/4	17,2	11,5	14,6	9,78				3360	343	378
60	2 3/8	18,6	12,4	15,8	10,5				3640	371	409
62		19,6	13,1	16,7	11,1				3840	392	433
64	2 1/2	20,9	14,0	17,8	11,9				4100	418	461
66		22,2	14,9	18,9	12,7				4360	444	490
	2 5/8	22,7	15,2	19,3	12,9				4450	453	500
68		23,6	15,8	20,1	13,4				4620	471	520
70	2 3/4	25,0	16,7	21,3	14,2				4900	499	551
72		26,4	17,7	22,4	15,0				5180	528	583
73	2 7/8	27,2	18,2	23,1	15,5				5330	544	600
74		27,9	18,7	23,7	15,9				5480	558	616
76		29,5	19,7	25,1	16,7				5780	589	650
	3	29,6	19,8	25,2	16,8				5810	592	653
77		30,2	20,3	25,7	17,3				5930	604	667
80	3 1/8	32,6	21,9	27,7	18,6				6400	652	720
82	3 1/4	34,8	23,3	29,6	19,8				6810	695	767
84		36,0	24,1	30,6	20,5				7060	719	794
86	3 3/8	37,7	25,3	32,0	21,5				7400	754	832
88		39,5	26,5	33,6	22,5				7740	789	871
90	3 1/2	41,3	27,7	35,1	23,5				8100	826	911
92	3 5/8	43,2	29,0	36,7	24,7				8480	864	954
94		45,1	30,2	38,3	25,7				8840	901	994
95	3 3/4	46,3	31,0	39,4	26,4				9070	925	1020
96		47,0	31,5	40,0	26,8				9220	939	1040
98	3 7/8	49,4	33,1	42,0	28,1				9690	988	1090
100		51,0	34,2	43,4	29,1				10000	1020	1130
102	4	53,1	35,6	45,1	30,3	10300	1050	1160			
104		55,2	37,0	46,9	31,5	10600	1080	1190			
105	4 1/8	56,2	37,7	47,8	32,0	10700	1090	1200			
106		57,3	38,4	48,7	32,6	10900	1110	1230			
108	4 1/4	59,5	39,9	50,6	33,9	11100	1130	1250			
109		60,6	40,6	51,5	34,5	11300	1150	1270			
110		61,7	41,3	52,4	35,1	11100	1130	1250			
112	4 3/8	64,0	42,9	54,4	36,5	11500	1180	1300			
114	4 1/2	66,6	44,6	56,6	37,9	11600	1190	1310			
115		67,4	45,2	57,3	38,4	11800	1200	1320			
117	4 5/8	70,4	47,2	59,8	40,1	12000	1220	1350			
119		72,2	48,4	61,4	41,1	12300	1260	1390			

Figures shown in this page represent the characteristics of the standard products. Redaelli is in position to design wire ropes to suit your individual needs. Please contact us directly and we will be pleased to design a specific wire rope to match your requirements.



# Spelter Sockets

## Open Spelter Sockets

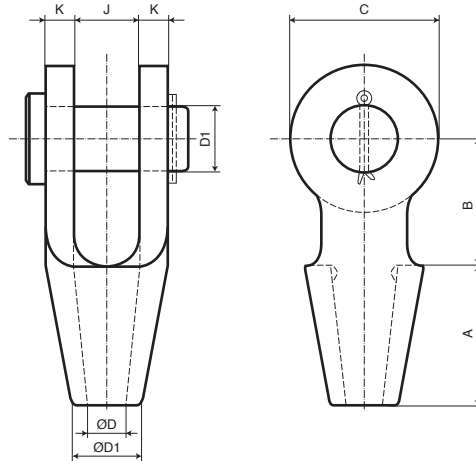

Nr.	MBL	Rope diameter		A	B	C	D	D1	J	K	Weight
	tons	mm	inch								
120	200	40-42	1 5/8	165	165	176	44	76	76	33	27,5
125	260	43-48	1 3/4 - 1 7/8	190	178	200	51	89	89	39	40,5
128	280	49-54	2 - 2 1/8	216	228	216	57	95	101	46	60,5
130	360	55-60	2 1/4 - 2 3/8	228	250	236	63	108	113	53	90
132	450	61-68	2 1/2 - 2 5/8	248	273	264	73	121	127	60	122
135	480	69-75	2 3/4 - 2 7/8	279	279	276	79	127	133	73	157
138	520	76-80	3 - 3 1/8	305	286	284	86	133	146	76	195
140	600	81-86	3 1/4 - 3 3/8	330	298	296	92	140	159	79	221
142	700	87-93	3 1/2 - 3 5/8	356	318	340	99	152	171	83	281
144	875	94-102	3 3/4 - 4	381	343	362	108	178	191	89	397
146	1100	108-115	4 1/2	460	480	440	125	190	208	101	570
150	1250	122-130	5	500	500	560	138	250	210	120	980
160	1400	140-155	5 1/2 - 6	580	500	600	160	275	230	140	-
170	1600	158-167	6 1/2	675	600	650	175	290	230	175	-



# Spelter Sockets

## Closed Spelter Sockets

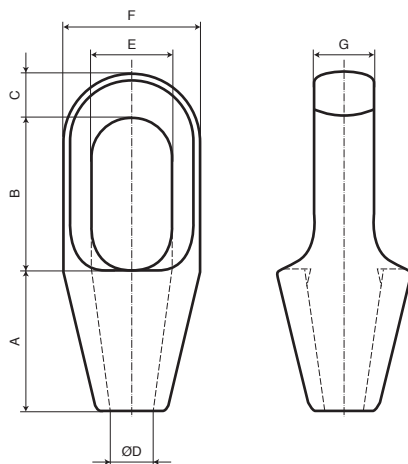

Nr.	MBL	Rope diameter		A	B	C	D	E	F	G	Weight
		tons	mm								
217	200	40-42	1 5/8	165	171	54	44	82	146	70	17
219	260	43-48	1 3/4 - 1 7/8	190	198	55	51	89	171	76	24
222	280	49-51	2 - 2 1/8	216	224	62	57	96	193	82	36,5
224	360	55-60	2 1/4 - 2 3/8	228	247	73	63	108	216	92	50
226	450	61-68	2 1/2 - 2 5/8	248	270	79	73	140	241	102	65
227	480	69-75	2 3/4 - 2 7/8	279	286	79	79	159	273	124	93
228	520	76-80	3 - 3 1/8	305	298	83	86	171	292	133	110
229	600	81-86	3 1/4 - 3 3/8	330	311	102	92	184	311	146	142
230	700	87-93	3 1/2 - 3 5/8	356	330	102	99	197	330	159	170
231	875	94-102	3 3/4 - 4	381	356	108	108	216	362	178	225
233	1100	108-115	4 1/2	450	425	120	125	235	405	190	340
240	1250	122-130	5	500	475	120	138	260	515	210	-
250	1400	140-155	5 1/2 - 6	580	550	150	160	300	510	250	-
260	1600	158-167	6 1/2	675	600	175	175	325	600	300	-

## CR-Sockets

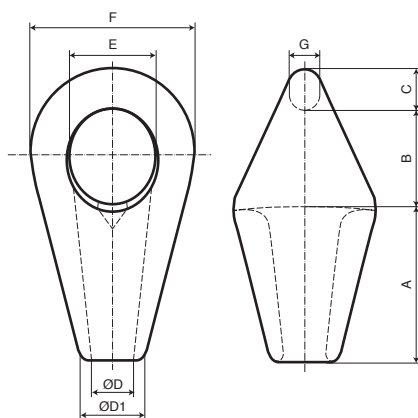

Nr.	MBL	Rope diameter		A	B	C	D	D1	E	F	G	Weight
		tons	mm									
517	160	37-42	1 1/2 - 1 5/8	160	110	42	44	70	92	130	38	± 10
519	200	43-48	1 3/4 - 1 7/8	188	128	50	51	80	110	180	45	± 17
522	250	49-54	2 - 2 1/8	215	125	55	57	80	115	200	50	± 24
524	300	55-60	2 1/4 - 2 3/8	230	145	65	63	90	135	230	57	± 33
526	400	61-68	2 1/2 - 2 5/8	250	160	75	73	113	160	265	65	± 50
527	500	69-75	2 3/4 - 2 7/8	280	175	80	79	119	170	278	70	± 59
528	600	76-80	3 - 3 1/8	315	210	85	86	126	184	300	75	± 74
529	700	81-86	3 1/4 - 3 3/8	340	205	100	92	132	204	320	90	± 89
530	800	87-93	3 1/2 - 3 5/8	360	220	105	99	140	215	340	95	± 104
531	900	94-102	3 3/4 - 4	380	240	110	108	150	234	376	100	± 134
533	1000	108-115	4 1/4 - 4 1/2	450	260	125	120	165	252	400	110	± 180



# Sockets for Permanent Mooring Lines

## Open Spelter Sockets S-type

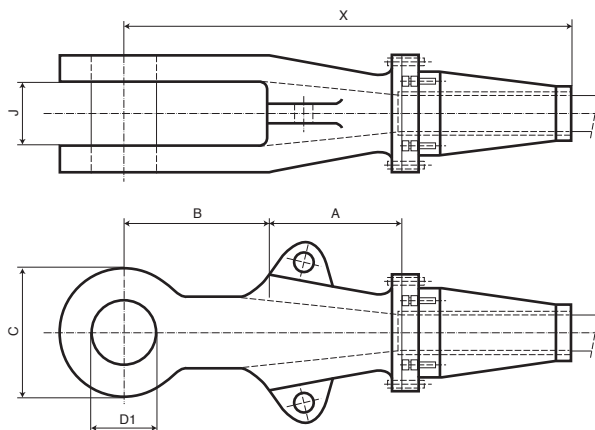

Nr.	MBL tons	Rope diameter mm	A mm	B mm	C mm	ØD1 mm	J mm	±X mm
332	450	61-68	300	279	276	127	133	1000
335	560	69-75	330	286	284	133	140	1000
338	650	75-84	375	298	296	140	159	1050
340	820	85-94	410	320	340	152	171	1170
344	1000	95-104	425	343	362	178	191	1300
346	1200	105-114	500	500	440	200	200	1570
350	1500	115-130	580	580	580	250	220	1800
370	1700	131-144	625	625	625	280	230	1940
380	1900	145-160	700	700	680	300	250	2150

Dimensions are estimated

## Closed Spelter Sockets S-type

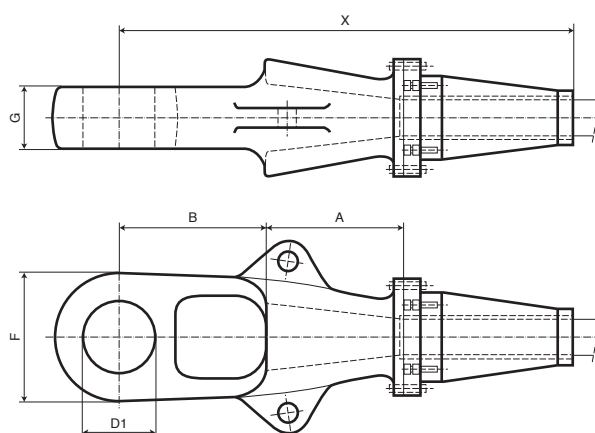

Nr.	MBL tons	Rope diameter mm	A mm	B mm	ØD1 mm	F mm	G mm	X mm
426	450	61-68	300	360	130	300	130	1000
427	560	69-75	330	370	140	320	140	1000
428	650	78-84	360	375	150	350	150	1110
430	820	85-94	400	410	175	380	170	1250
431	1000	95-104	425	450	205	400	200	1400
433	1200	105-114	500	500	230	500	210	1570
440	1500	115-130	580	570	260	600	225	1800
445	1700	131-144	625	630	300	680	240	1940
450	1900	145-160	700	700	325	725	275	2150

# Technical Information

## Handling

The wire rope is supplied on a steel reel supported by a wooden or steel cradle, which is not permanently connected to the reel. The bent nails or wire hooks connecting the cradle with the reel are installed only for aligning the reel with the cradle.

If not provided with special fittings, the reel must be lifted using a proper shaft to be inserted in the reel hole and the shaft must be connected with slings to a suitable lifting beam.

To relocate the reel, the cradle must be connected to the lifting shaft using textile or steel ropes to prevent its falling down during lifting. To install the reel over the pay off, the cradle must be disconnected from the reel before lifting.

For the uncoiling operation, the reel must be placed over the pay-off so that the end will be extracted from the bottom.

After the installation of the reel and before removing the lifting tools, reel rotation caused by its unbalanced weight must be prevented.

The outer rope end must be disconnected from the reel taking care to prevent any rope reactions.

The braking system, if required, shall engage at least two opposite reel rays and must be capable to work in both directions.

The rope end must be connected to the pulling rope by a suitable connection capable to withstand the required pulling force, which should not exceed 2 tons using one braking device or 5 tons using two braking devices (one at each rope side).

## Storage

Ropes are supplied with a lubrication which protects them during transportation, a certain period of stocking depending on the ambient atmosphere and the initial period of use.

Ropes must be stored in a vertical position (with the axis of the steel reel parallel to the ground) in a cool, dry, clean and well ventilated indoor warehouse, avoiding the contact with the ground.

All the ropes standing outside must be placed in suitable supports for the storage reels to avoid the penetration of the steel reel arms on the ground.

They must be protected with breathable waterproof fabric covers that don't allow the formation of humidity and condensation and secured in order to maintain a proper ventilation.

If the rope has to be stocked for long periods, especially in the case of high temperature locations, it should be periodically rotated of half a revolution to prevent the lubricant draining. This operation should be performed with a higher frequency in case of temperatures higher than 25°C.

At the same time, the wire rope should be checked to detect any trace of corrosion or inadequate lubrication.

Ropes which have been stored for a long time should be in any case cleaned to remove scales, fouling or incrustation, then lubricated and, if possible, dipped in oil before installation.



## Installation on drum

When the rope is coiled on a drum, it is bent and slightly twisted: a drum with right pitched grooves induces untwist into a left hand lay rope, a drum with left pitched grooves induces untwist into a right hand lay rope.

When the rope leaves the drum, a certain amount of additional twist builds up in the rope. Redaelli fully non rotating wire ropes are specially designed to resist the additional twist so as not to affect the performance of the product.

As a general rule, for the coiling operation on a single layer grooved drum having a right hand pitch, a left hand lay rope is recommended. Similarly, for a grooved drum having a left hand pitch, a right hand lay rope should be used.

The general rule must be observed with fully non-rotating ropes like Flexpack to avoid permanent changes of the structure of the rope. These ropes are particularly sensitive to twist, since their core is closed in the opposite direction to the outer strands.

With non rotation-resistant ropes (RED1 or PACK9), which have a good degree of compactness and robustness, the use of a rope with the apparent wrong direction of lay according to the general rule may be allowed.

In the case of coiling on multiple-layer grooved winches (like Lebus models), the direction of the lay is not strictly determined by the direction of the pitch of the grooves in the drum.

In some particular cases, it could be advantageous to select a rope having the same lay direction of the layer that is more frequently wound and unwound on the drum.

In the case of multiple layer on plain drums, it is recommended to design the rope length in order to utilize the first layer as a bedding for the following ones. This layer should also be painted in order to clearly identify it and to avoid to utilize it for the working operations.

When installed on the drum, the wire rope must be properly tensioned in order to allow a correct coiling and uncoiling operation.

**The preload or “backtension”, which is the load on the cable on the cable drum, should be at least 2% of the minimum breaking force or 10% of the working load limit (considering the highest among the two values).**

## Training

**Every rope should be trained before use.**

A wire rope is composed of several components (wires, strands, core), which have been laid, during the production, using forces which are much lower than those applied during service.

The rope denotes a non linear behavior at very low tension, while for higher values of load and further loading cycles, it keeps the memory of the solicitations and shows a progressive reduction of the non-linear portion of the curve with the reduction of the total rope elongation.

This behavior is due to the fact that at low tensions some wires or strands are more stressed than others, while at higher tension values the rope stabilizes and its components have a better cooperation level.

The torque produced by the rope depends on torque factor, diameter and tension, which is proportional to the depth.

The rope rotation is proportional to the torque and depends on the rope rotation factor and length.

For more details regarding wire rope torque, see the dedicated section of this catalogue.

In Abandonment and Recovery application, before the beginning of pipeline abandonment, the rope should be lowered in single fall configuration at the same depth required for abandonment and left in such a position for some minutes in order to allow the elimination of its inertial movement, then it must be re-wound on the winch. To achieve a full balance, these lowering and re-winding operations should be performed 3 times.

During the last preliminary winding cycle, it is useful to paint a straight line parallel to the winch axis for each rope layer, which will be used as a reference to monitor the possible wire rope rotation.

It is important to remark that, since after the rope torsional stabilization the storage winch contains a geometrically distorted rope, the rope must always be under tension to avoid the generation of twists and kinks.

The maximum operating depth of the rope must be determined depending on the rope type.

Typically, 6 strand ropes can work up to 1300 m depth, 8 strand ropes up to 1000 m, non rotating ropes have no practical limitations.



## Elastic modulus and elongation at break

The elastic modulus describes the capability of a material to have an elastic deformation when a force is applied on it.

The most common elastic modulus is the tensile or Young's modulus, which is the slope of the linear area of the stress-strain curve (see figure) and is defined as

$$E = \sigma / \epsilon$$

where  $\sigma$  is the tensile strength (ratio between applied force and section area) and  $\epsilon$  is the tensile strain (ratio between deformation and initial length)

This definition is valid for isotropic materials subjected to an axial stress.

Since a wire rope is not an isotropic material and its components are not subjected to axial forces, due to the fact that they are inclined with specific closing angles, it is more appropriate to refer to an "apparent tensile modulus".

Looking at the graph below, we can see that in the very first area (from the origin to point 1) the rope wires show a non linear behavior due to the stabilization of its components. As already clarified, this stabilization is due the fact that during closing operation there will be some light differences in the tensioning of the different wire rope components.

After the stabilization point, the wire rope enters the proportional area characterized by the apparent tensile modulus. In this area, the rope will have an elastic behavior: this means that when load is taken off, the wire rope will come back to its original length (except the first stabilization length).

At a certain point, the rope will start to show plastic deformation (point 2 to 4): when the permanent deformation exceeds the 0.2%, the yield point (point 4, which is also called  $R_{p0.2}$  point) is reached and the graph goes on with non linear trend until the elongation limit, which corresponds to the maximum breaking force value.

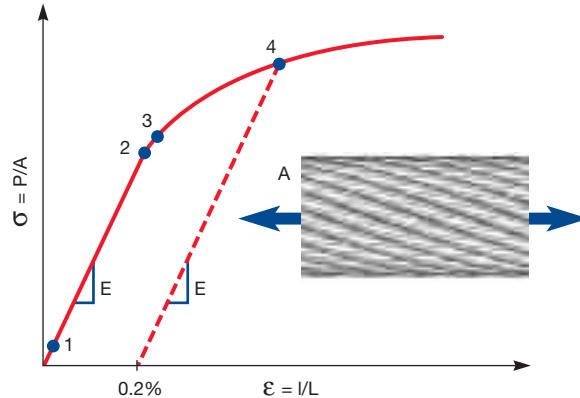

Each wire rope is designed to operate in a certain range of the linear portion depending on the required safety factor. High safety factor means that the rope will work in the lower range of the linear area, while low safety factor means that it will work closer to the yield limit.

Each wire rope can absorb a certain quantity of energy, which depends also on the grade of the single wires: very high grade wires have already absorbed a large quantity of energy during the drawing process and therefore they have a lower value of residual energy which can be utilized for the elongation.

As already explained, if the stress to which the rope is subjected to reaches the yield value, the rope will enter in the plastic area of the graph. The rope will absorb a certain amount of energy and it will maintain a permanent deformation even if at a certain point it is unloaded.

This process will go on until no more residual energy is available: at this point, the rope will reach the elongation limit and the corresponding maximum breaking force and it will suffer damage and break.

**The long area of plastic elongation and energy absorption is essential from the safety point of view, since it implies that a rope won't break suddenly and unexpectedly, but it will have a "warning period" in which the damage can be clearly detected by a competent person.**

## Radial stiffness

Radial stiffness is an essential characteristic in many rope applications, for example on multi layer winch drums, where the rope is subjected at the same time to the pulling force of the traction winch and to the compression of the adjacent layers.

An excessive wire rope deformation can generate a heavy flange shear stress, while an excessive wire stiffness can cause a drum hoop stress.

In both cases, severe damage to the winch may occur.

Radial stiffness correlates pressure and radial deformation following the definition

$$K = \frac{P}{\Delta d/d}$$

where  $P$  is the pressure to which the wire rope is subjected and  $\Delta d/d$  is the variation of the wire rope diameter.

Redaelli conducted several experiments to measure the radial stiffness of different wire rope constructions, as summarized in the graph below.

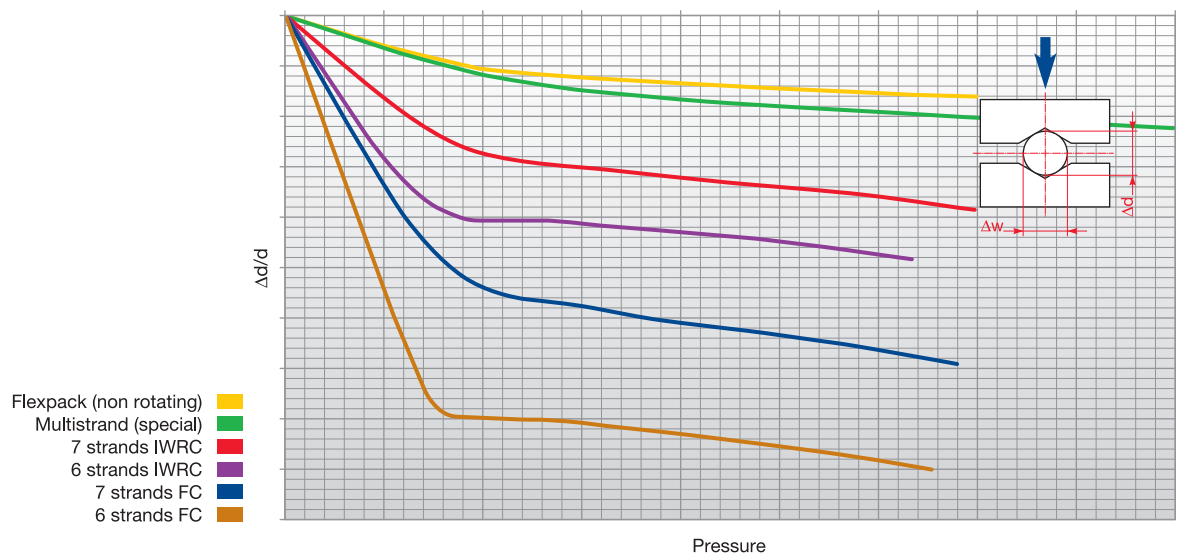

For each curve, two main areas can be identified: the main ratio of the diameter variation is obtained during the first stage of compression, while after having reached a certain deformation value, the diameter variation slows down and the curves show similar slopes.

**Six and seven strands fiber core wire ropes are the most sensitive to the compression effect, while the special compacted ropes (Flexpack and independent wire rope core) have a much higher diameter stability towards pressure.**

It has to be noted that after each pressure cycle the wire rope denotes a certain degree of permanent deformation.

This permanent deformation is particularly significant after the first cycle, while after a few cycles the rope diameter shows a stabilization.



## Loss of strength due to ageing

The minimum breaking force (MBF) is the specified value below which the measured (actual) breaking force is not allowed to fall in a prescribed breaking force test. [EN 12385-2 3.10.10]

Breaking force is a very simple criteria for rope acceptance which was selected more than a century ago because it was the only measurable element, even if there are many other rope characteristics which should be considered, like for example yield stress, proportional stress, fatigue limit stress, etc.

**An excess of MBF is not a true safety parameter and does not generate a safety increase, since it is achieved pushing up one or more design variables.**

Two common methods to increase the MBF are the use of high strength wires, which on the other hand reduces the wire ductility, and the use of a large number of small wires, make it easier to obtain higher strength but reduces drastically the cooperation level of the rope components.

Wire ropes which are composed of wires having similar diameter and properties can reach the MBF without overstressing the design parameters, therefore they ensure a uniform behaviour of all the components, a better efficiency of the material and a more reliable service life.

Each steel wire rope will reduce its breaking force during its service life. This reduction depends on reduction of metallic area, material modifications and geometrical modifications and in some cases it may occur also if the rope has not been used.

The reduction of breaking force may also be caused by ageing, which is a process which generates a continuous increase in the hardness of a metal.

**Ageing cannot be prevented, because it is an intrinsic phenomenon of each wire rope, which is subjected anyway to time and temperature independently of the rope maker measures adopted during production.**

Ageing is influenced by temperature, since the exposure to high temperature (conventionally higher than 80°C) for a short time or relatively low temperature acting for a long time could modify the material properties.

In the past, a focus was put on the galvanizing process, which is mandatory to prevent corrosion and which could affect ageing, since is performed at very high temperatures.

It has instead to be underlined that the modern high speed drawing process has been demonstrated to prevent the ageing process.

The cold forming process for high strength wires, especially in case of large wire diameters, can facilitate the ageing process. This is due to the fact that, to obtain high grade steel, a huge quantity of energy must be supplied to the wires, drastically reducing the ductility of the steel.

Wires having a grade of 1960 or lower can maintain an acceptable ductility even after ageing, therefore in this case the reduction of breaking force values would be very limited.

Also wires compacting, which implies a high quantity of energy absorption and heat generation, could theoretically affect ageing, but the modern compacting technologies minimize wire heating and exposition time using rollers and double pulling capstans which improve strands rapid cooling.

It is important to underline that the reduction of the measured breaking force of a wire rope stored for a long period is not generally demonstrated.

The variation in the wires ductility due to ageing affects the rope behaviour only in the plastic part of the load/elongation curve, therefore the fatigue performance of aged ropes is not affected, because the applied loads must always be lower than the yield point.

**The reduction of breaking force does not indicate a corresponding reduction of the fatigue performances, therefore the measured breaking force on an aged rope should be disregarded as an index of the remaining life of the product.**

## Rotation stability

Wire rope rotation stability is related to the capability to generate reduced torque or rotation when subjected to an axial force.

**The maximum recommended fleet angle value is 2 degrees, 4 degrees for plastic impregnated ropes.**

Each wire rope is composed of a certain number of wires having a helix closing, therefore they have the tendency to untwist to reach a more stable configuration and to allow a higher elongation value.

The torque generated by a wire rope depends on the rope diameter, the applied force and the characteristic torque factor, which depends on the rope construction.

Six strand ropes with steel core have a high torque factor, while non rotating wire ropes have a low torque factor.

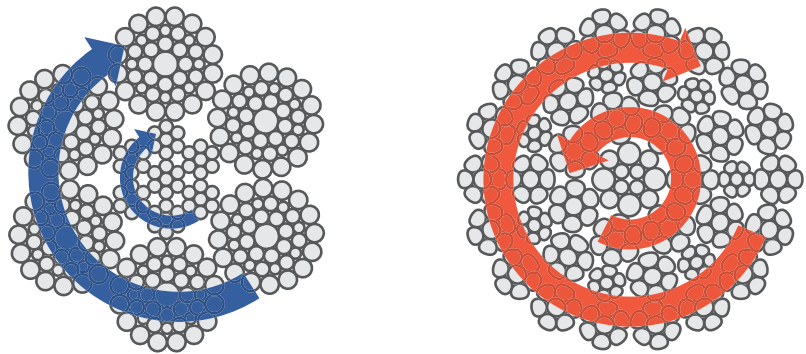

In a capstan the rope is subjected to several bends and fleet angle and moreover its tension changes from the maximum pulling force to the back tension provided by the storage winch.

At the “load side” and at the “winch side” the rope generates torques depending on the type of rope, its size and the applied tensions (loads).

Usually the back tension is very low compared with the pulling force, therefore the torque has different values along the capstan.

The change of the torque is compensated by the rope rotation, but the free rotation of the rope is prevented by the friction of the rope itself over the capstan sheaves, therefore the rope rotation takes place only when it leaves the capstan (at the “winch side”).

This rotation forces a geometrical distortion of the rope and it can create kinks on the rope if the back tension is not high enough to prevent them.

The usual short distance between the capstan sheaves does not allow the proper distribution of the stress along the rope and this creates uneven stress conditions of the rope components resulting in a reduction of the life (usually for A/R application this is not a major problem)

When the rope moves from a groove to the next one, it is subjected to a lateral deflection and this implies that the rope reaches the sheave groove on its side absorbing an additional torque.

Such torque is added to the internal torque created by the rope tension (load).

A rope with a high rotational stiffness has a small geometrical distortion but a high residual torque due to its rotation. In this case some problems may occur if the torque is not properly managed.

A rope with a low rotational stiffness has a high geometrical distortion but a small residual torque due to its rotation. In this case the geometrical distortion may be of such entity as to affect the rope breaking force and its performance in service.

A non rotating rope construction ensures a high control of the rotation of the load, but requires a capstan and a storage winch and very skilled personnel.

A standard rope construction doesn't require a special machine, but it could be permanently damaged after the first operation.

## Rotation trend

In the following graph the rotation of the rope depending on the load is represented.

It is clear that non rotating wire ropes, like Flexpack, show a much lower rotation than the non rotation resistant versions.

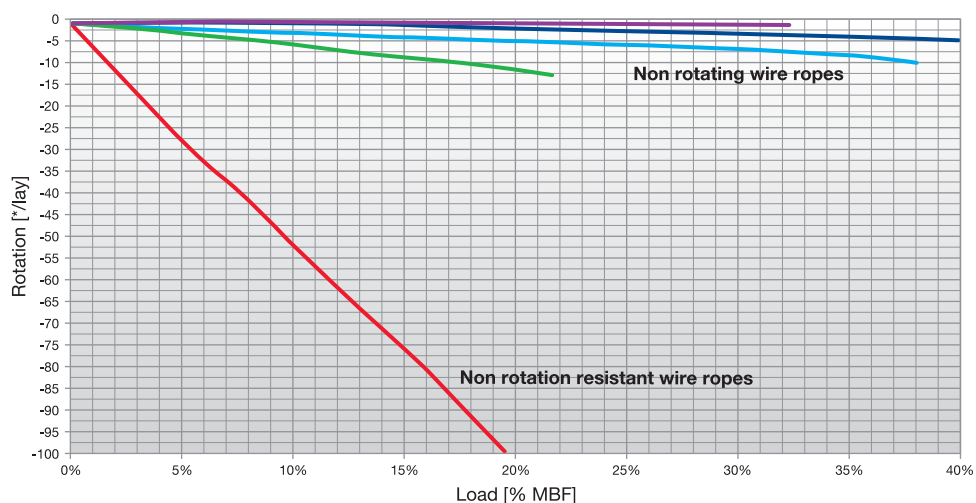

## Bending stiffness

Bending stiffness is an essential characteristic of each wire rope which is related to the force that the wire rope exerts when it is bent in round shape.

The bending force depends on the square diameter of the rope and on the force factor, which depends on the wire rope configuration, as indicated in the graph below.

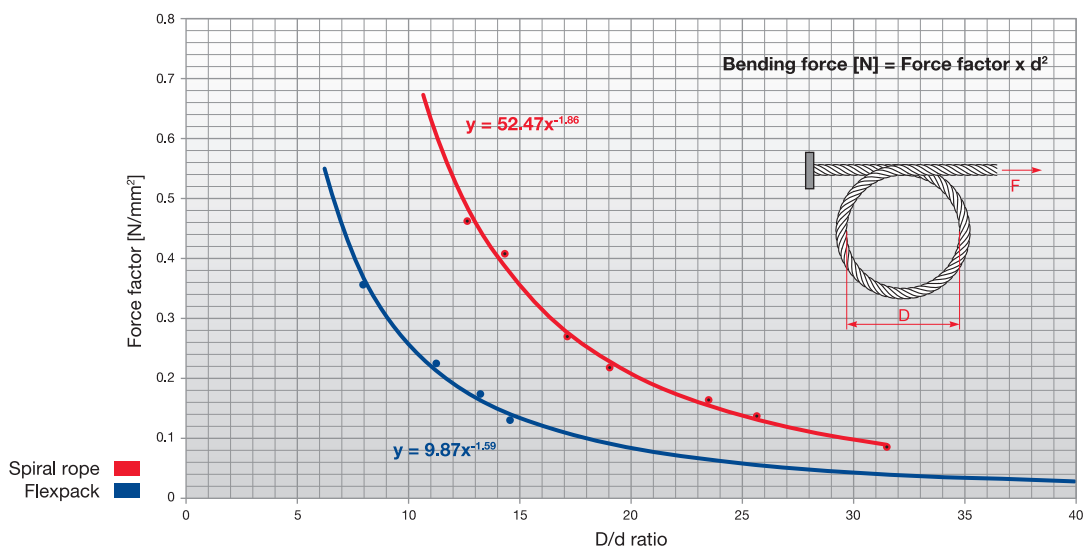



# Technical Information

## Swivels

All the non rotating Redaelli special wire ropes like Flexpack, not having the tendency to unlay under load, can be used with a swivel at one end.

The swivel can be recommended for particular crane applications, for example to lift weights at great heights or for long periods of continuous repeated work.

Swivels can be used only with non rotating ropes, since non-rotation resistant ropes would untwist under load, causing permanent changes in their structure and reduction of the mechanical properties.

In order to prevent unlaying, non-rotation resistant steel wire ropes must be fixed with both ends secured against rotation.

Rope swivels, Crosby Laughlin different types:



## End terminations

Redaelli can provide wire ropes with different end terminations depending on customer needs.

The most typical end terminations are:

- Plain
- Fused and tapered (up to 24 mm diameter)
- Peeled off
- Welded eye
- Becket loop
- Special socket for connection to Lebus winch

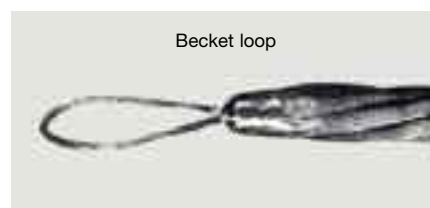



# Summary of technical information (for guidance only)

Construction	Spin Factor $K_R$	Mass factor $k_M$		Fill factor F	Elastic modulus	Axial stiffness factor	Torque factor	Rotation factor
		in air	in water					
Flexpack 15	0,92	0,0049	0,0042	0,73	130	94,9	0,01	1
Flexpack 18	0.92-0.83	0,0049	0,0042	0,74	130	96,2	0,007	0,5
Flexpack 21	0.83-0.76	0,0047	0,0040	0,72	130	93,6	0,002	1,2
6x19 API		0,0042		0,59	110	65,5		
7xk19	0.87-0.85	0,0044		0,68	120	81,6		
Pack9-Pack9P	0.96-0.80	0,0047	0,0040	0,69	115	79,4		
Red1	0.84-0.66	0,0043	0,0036	0,60	105	63,0		
Pack1	0.89-0.77	0,0045	0,0038	0,67	125	83,8		
Spiral Ropes	1-0.87	0,0051	0,0043	0,74	155	115		



## Use and warnings

During all the handling operations, the rope must not be in contact with ground, edges or inadequate environment.

In the case of spooling on a drum or winch, the rope must be unwound using a proper tension (2% of the MBF or 10% of the working load) and avoiding excessive fleet angles.

Moreover, the drum on which the wire rope is supplied with must be properly braked to avoid overturning.

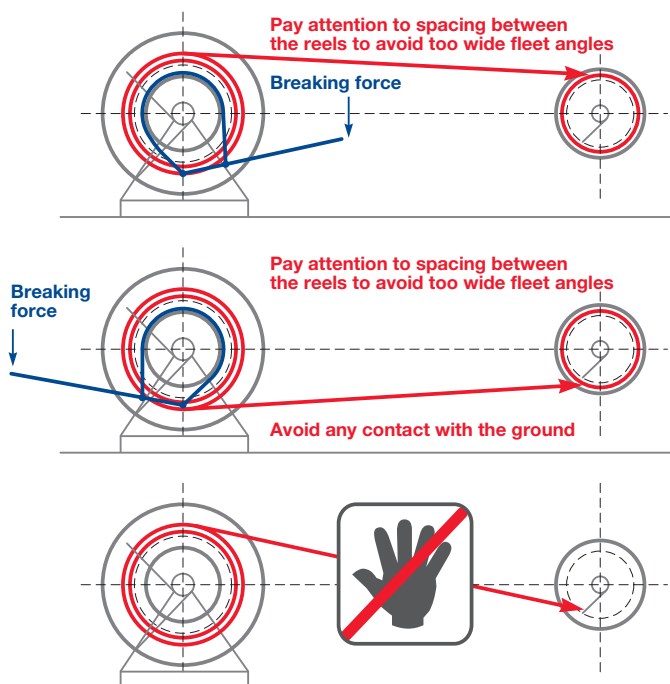

A correct groove dimension is essential to guarantee a good rope behaviour and avoid rope damage: the first figure represent a narrow groove, the second one a correct groove, the third one a large groove and the fourth one a worn groove which needs to be reworked.

For wire ropes having 0-4% diameter tolerance, the recommended groove oversize is 8%.

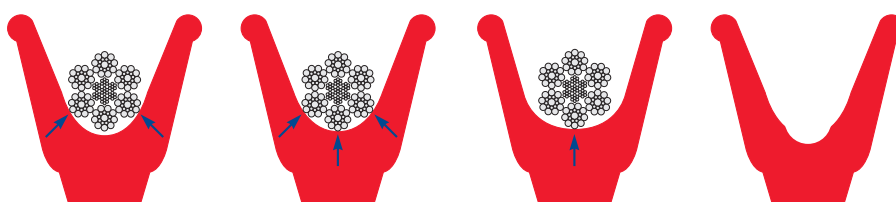

The groove diameter should be checked using proper gauges: the left photograph represents the inspection of a narrow groove using a calibrated ring, which underlines the inadequate groove diameter, while the right one represents a go-no go template which indicates the upper and lower tolerance limits of the groove.



## Servicing

A serving is a wrapping of single wire laid tightly around a rope to prevent its wires from kicking or moving to slacken themselves when the rope is cut between two adjacent servings.

It must be applied using a serving mallet to keep it under proper tension and get it tight.

The serving wire should be tinned annealed mild steel or soft iron wire and its size should be selected depending on the rope diameter (see table below).

To perform a proper serving, the following tools are required: a vice to hold the rope, serving mallets having shaped heads made of soft material not to damage the rope, a reel which can be mounted on the mallets, pliers and wire cutters, a soft head hammer and a heavy soldering iron.

The length of the serving depends on the purpose of the serving itself and on the size and type of the rope. If the purpose of the serving is to restrain the cut end of a rope, it must be longer than one intended to restrain the end of a short sample to be cut from a rope.



**For the cut end of six strands ropes, two servings each of a length at least six times the rope diameter should be used.  
For the cut end of a large spiral or locked coil rope a serving or servings each a length of twenty times the rope diameter is advisable.**

Servicing must be kept in place until the rope end is otherwise secured. In case of large spiral or coiled rope, serving should also be backed up by a minimum of six two-bolt clamps set clear of the served length.

There are two types of serving: the ordinary one and the soldered one.

The ordinary or buried-wire serving is usually confined to stranded ropes and to parts of the rope which have not to be fitted into sockets or other confined spaces.

It is achieved by laying the first part of the serving wire along the length of rope to be served, and then by winding the wire tightly over it in coils so that the two ends of the serving wire finish at the same place where they can be twisted together and cut off short to complete the serving.

The soldered or wiped serving is the best type of solution. It is suitable for spiral and locked coil ropes and for parts of rope which are to be threaded through sockets.

This serving is performed directly on the rope, without any buried wire being present, so that the two ends of the serving wire lie at opposite ends of the serving.

Sizes of tinned annealed mild steel or soft iron serving wire for ropes of various sizes		
Rope diameter	Size of single serving wire	Standard wire gauge
mm (inch)	mm	SWG
Less than 22 (7/8")	1.30÷1.50	17
From 22 to 38 (7/8"-1.1/2")	1.50÷1.70	16
Larger than 38 (>1.1/2")	1.80÷2,20	15

## Socketing

Socketing is an essential operation to guarantee the proper interface of the rope with the winch or other devices.

To perform a proper socketing, the following steps must be observed.

- 1 Wire rope cutting
- 2 Socket assembly
- 3 Brush preparation
- 4 Brush degreasing and drying
- 5 Socket positioning
- 6 Resin preparation, pouring and curing
- 7 Top sealing (if required)
- 8 Socket disengagement



## Inspection

The most widely used wire rope replacement, inspection and maintenance standard for running ropes installed on cranes is ASME B30.5, section 5-2.4.

All wire rope in continuous service should be observed during normal operation and visually inspected on a periodical basis.

Wire ropes which have been idle for a period of a month or more should be given inspecting before putting them back into service.

The time to remove a rope from service is related to the conditions of the particular installation. These conditions include the size, nature and frequency of the lifting operations, when the next inspection will be, what the operating and maintenance practices are and the extent of possible or probable injury to people, loss of life, material damage, etc., should the rope fail.

The inspector must decide if the rope condition presents any possibility of failure, and if the rate of deterioration of the rope is such that it will remain in safe condition until the next scheduled inspection.

The frequency of detailed and thorough inspections should be determined by a qualified person, considering expected rope life as determined by maintenance records and experience, severity of environment, percentage of capacity lifts, frequency rates of operation and exposure to shock loads

The parts of the rope which are most repeatedly placed under stress (for example, the ones close to end attachments, equalizing sheaves, winches, sheaves) or exposed to heat must be carefully inspected.

Every periodic inspection must include diameter measurement at critical points and recording of measurements for future comparisons.

The number of broken wires on the outside of the wire rope is an indication of its general condition and whether or not it must be replaced.

If ends of broken wires which might cross adjacent wires and destroy them when running over sheaves are detected, they must be removed by moving their ends backwards and forwards until they break deep in the valley between two outer strands.

Each sheave should receive an individual examination: the groove must be checked carefully to verify whether the contour of the gauge matches the contour of the bottom of the groove.

The winches must be inspected considering minimum number of dead wraps to remain on the winch, condition of winch grooves and surface, condition of flanges at the ends of the winch, rope end attachment, spooling characteristics of the rope.



*Wear with broken wires due to fatigue*



*Crushing and flattening on winch*



*Protrusion of the steel core due to rope rotation*



*Fatigue breaks with no evident wear*



*Protrusion of internal wires due to narrow grooves*



*Birdcage due to rope rotation*



*Dramatic breakage due to rope rotation*



*Wire displacement due to narrow groove*



*Internal corrosion*



*Breakage of steel core due to overload*



*Localized damage due to improper assembly*



*External corrosion*



*Abrasion on a sharp edge*



*Waving due to alternate loads*



*Birdcage due to sudden release of the load*

# Technical Information

## Lubrication

During the manufacturing process the rope receives a proper lubrication which provides protection against corrosion and internal and external friction for a certain period of time.

During the working life the initial lubrication may expire, therefore the ropes have to be re-lubricated, particularly along the zones subjected to bending, using a lubricant in accordance with the recommendations of the rope manufacturer.

Service must be carried out regularly depending on the lifting device, application and type of rope. If relubrication is not performed properly and regularly, a severe reduction of rope service life has to be expected.

The application of lubrication with brushes, rags, gloves, or by other means is costly, risky, and ineffective, since it forms a film on the surface which water vapour can penetrate, generating condensation and rust starting from the inside.

In this case, the wire rope can appear externally in good conditions, while corrosion and friction are destroying it from the inside.

If only a little lubricant is required, pressure spray nozzles can be used, even if the optimal lubrication process is the use of a high pressure system at 20 bar minimum (285PSI), which guarantees the lubricant penetration between the strands also inside the rope.

It can also be used as a wire rope cleaner before the application of lubricant in cases where ropes operate in extremely abrasive conditions or are subjected to chemicals.

This system can use a wide range of lubricants (except Bitumastic ones) but higher viscosity products are recommended. Oil or liquid lubricants will disappear very fast from the rope.

Before choosing the re-lubricant, it must be ensured that it is in accordance with the lubricant applied during manufacturing (Nyrosten T55 based lubricant), so please contact Redaelli Customer Service in case a different lubricant is normally used.



# A Giant Rope, a Rope for Giants

## December 2009 Opening of Redaelli new factory at the harbour of Trieste (Italy)

With almost 200 years experience as wire rope manufacturer and with the new plant in Trieste, Redaelli is one of the leading hi-tech steel wire rope producer. The new plant is capable to produce presently the biggest state of the art steel wire ropes in the world.

The location of the plant at the dockside of Trieste harbour allows the loading of the huge reels without any preliminary land transport.



## March, 2010 Redaelli manufacturers a world record steel wire rope

Redaelli, the Italian leading manufacturer of hi-tech steel wire ropes and tensostructure engineering, breaks a new world record: the production of the heaviest steel wire rope in the world with a net weight of 361,1 tons.

The record has been certified by Guinness World Records Ltd.

The record-breaking FLEXPACK rope, a compacted non-rotating steel wire rope, is 3020 meters long and has a nominal diameter of 160 mm.



# A Giant Rope, a Rope for Giants

## Redaelli again breaks the Guinness World Record

A new prestigious award with Flexpack, a 152 mm compacted non-rotating steel wire rope for offshore applications, that weights over 420 tons.

A technological and industrial success that Redaelli devotes to the 150th Anniversary of the National Unity. With its products Redaelli also exports a worldwide international award, an award recognizing once again the strong Italian style to innovation.



## The Company

Founded in 1819, Redaelli started up as a steel drawing mill in the area of Lecco, Italy. Around 1860, the original mill expanded into a larger factory and in 1870 it became a share capital company.

By the 1980's, Redaelli had begun to diversify its activities by expanding its product range into the fields of steel cord for the reinforcement of tyres and the design and construction of steel drawing machinery.

In July 2008 the activities of steel cord and pre-stressing were sold and the Company then with ropes as its core business became part of the Severstal-metiz group of companies.

Now, Redaelli is a leading international manufacturer of steel wire ropes used in a variety of applications, including suspension bridges, cableways and cranes; service and distribution of lifting system; engineering of tenso structures.

Redaelli is positioned to pursue attractive growth opportunities in each of its three business areas.

As a matter of fact, the presence in so many different market sectors ensures ongoing growth of production volumes and profitability, whilst the expansion policy outside Europe - mainly in Far East, USA, and Emerging Markets - is undergoing a consolidation process, which includes new clients and new fields of action.

The Company is based in Milan, Italy and has plants and operations in Italy, at Gardone Valtrompia (Brescia) and Trieste, with around 300 employees in total.

A central corporate structure covers the functions of marketing and communications, raw material purchasing, finance and control, and quality assurance.

This integrated organization allows Redaelli to efficiently and quickly react to market events and trends, lever on common technologies, have a better purchasing power, and optimize its financial resources.

Today Redaelli Tecna S.p.A. is 100% owned by JSC "Severstal-metiz".



# Redaelli

**Redaelli Tecna S.p.A.**

Via A. Volta, 16  
20093 Cologno Monzese (MI, Italy)  
Tel. +39 02 25307219 - Fax +39 02 25307212  
E-mail: [wireropes@redaelli.com](mailto:wireropes@redaelli.com)

## Factories:

Via Matteotti, 323  
25063 Gardone Val Trompia (BS, Italy)  
Tel. +39 030 89171 - Fax +39 030 8917814

Riva Alvise Cadamosto, 14  
34147 Trieste (Italy)  
Tel. +39 040 2820943 - Fax +39 040 2820943

[www.redaelli.com](http://www.redaelli.com)